

WWW.NANLITE.COM

# NANLITE

*PavoSlim 120B* LED Bi-color Panel Light

# NANLITE

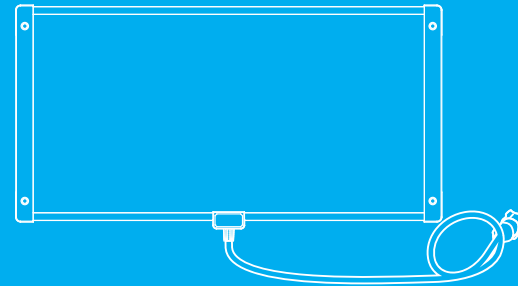

USER MANUAL

☎ 0754-85751187

✉ info@nanlite.com

☎ 0754-85300887

📍 Dongli Section, Highway 324, Chenghai, Shantou City, Guangdong Province, China

Guangdong NanGuang Photo&Video Systems Co., Ltd.

## ■ Introduction

Thank you for purchasing Nanlite product -- PavoSlim 120B!

The bi-color slim panel light is designed for content creators and commercial shooting teams. It possesses color temperature ranging from 2700K to 6500K (promptly toggle between common used CCT by short press) and 12 effects. The parameters of each effect is fully tunable for more creation possibilities. It can be powered via the AC, DC socket and V-mount batteries including 14.4-14.8V and 26V. PavoSlim 120B also provides multiple control options of on-board, Nanlink App and DMX/RDM, meets the control requirement from basic to professional-grade. The included softbox, diffuser and eggcrate will further unleash users' creativity.

With slim and lightweight fixture body of 2×1"size, PavoSlim 120B is suitable for most scenes, particularly the small space, run & gun situations, providing a great help on film and television production, photography and content creation lighting setup.

## ■ Notice

1. Please do not look directly at the emitter when the fixture is on.
2. Please do not place any object on the fixture or allow liquid to flow inside the fixture.
3. Please do not place the fixture near any flammable or volatile substances like alcohol or gasoline.
4. Please do not use strong detergent for cleaning. Please wipe off the dirt by using a cloth with neutral cleanser when cleaning the fixture.
5. Please set up the fixture in a dry and well-ventilated place. Please do not use it in any humid, dusty or overheated environment. Meanwhile, please also check whether the fan and vent are unimpeded.
6. Please do not disassemble the fixture to repair at will. Qualified professionals should conduct maintenance under the condition of strictly following the operating procedures described in this manual.
7. Please do not cover the vents when using, to avoid affecting heat dissipation, and resulting in damage. Please pay attention to anti-scald when using the fixture for a long time, since the surface temperature of fixture will be high.

## *PavoSlim 120B* LED Bi-color Panel Light

### ■ Product Diagram

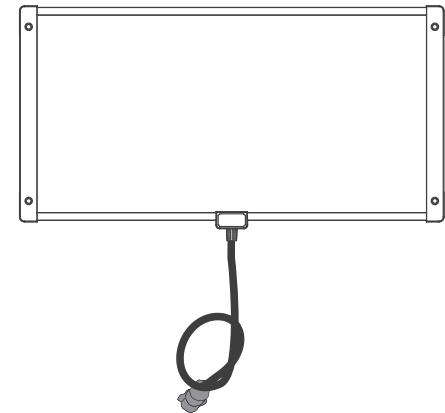

### ■ Technical Data

Rated Power: 150W

Input: DC 24V

DC (Battery) 14.4-26V

AC100-240V 50/60Hz

Color Temperature: 2700K-6500K

CRI: Average 95

TLCI: Average 97

Product Details

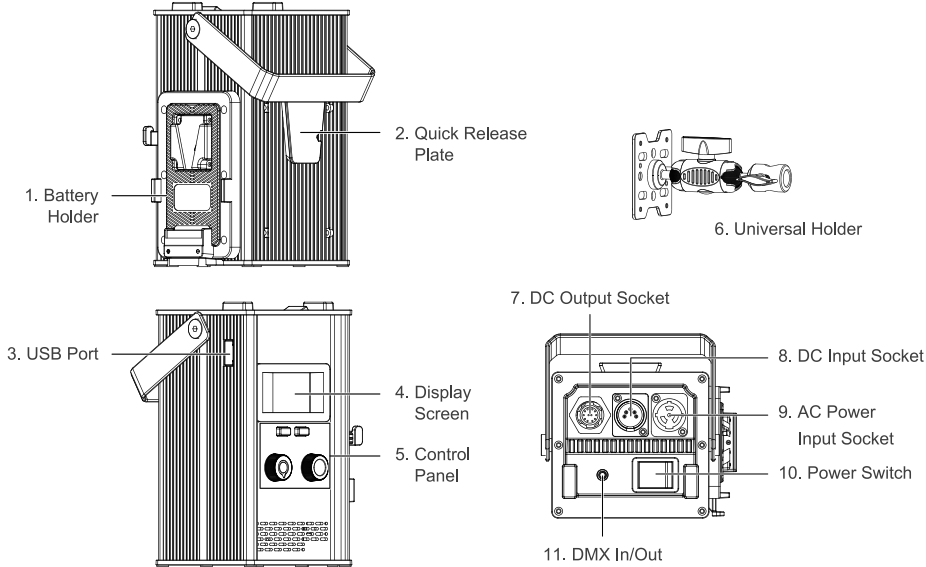

021 NANLITE

Certification



Made in China

Please scan the QR code for more details.



DMX Reference Guide



Detailed User Manual











Nanlite Website

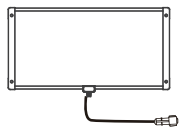
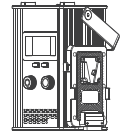

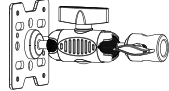
Nanlink App

This manual has been compiled according to the rigorous testing for Nanlite products. Product designs are subject to change without prior notice. The latest version of the manual for this product is downloadable at [www.nanlite.com](http://www.nanlite.com).

## Includes

PavoSlim 120B x 1	Control Unit x 1	DC Connection Cable x 1	AC Power Cable x 1
			
Universal Holder x 1	Softbox x 1	Diffuser x 2	Eggcrate x 1
			
Carrying Bag x 1	User Manual x 1		
			

## Usage

### 1. Connection Between Light Fixture, Control Unit and Power Supply.

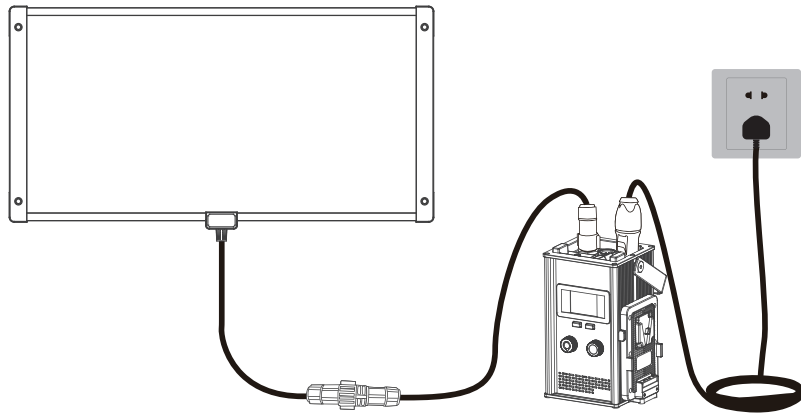

#### Note:

- 1.1. When connecting the power supply, please make sure the power voltage are consistent with that indicated on the control unit.
- 1.2. Make sure to use the included AC power cable and control unit. The connection between the DC output socket and the DC connection cable from the fixture body should be done as shown above.

04 | NANLITE

## General Fault Detection and Diagnosis

Fault Detection	Diagnosis
The fixture won't boot up properly. Check whether the display screen is normal.	1. Please check whether the connection between control unit and fixture are loose if the display screen can work. 2. Please check whether the voltage is within the specified range or the connection cable is loose if the display screen can't work.
The fixture can be operated manually, but DMX control is not working.	1. Please check whether the DMX address setting of the fixture is correct. 2. Please check whether the DMX cable is connected correctly and without damage.
If the fault is not resolved after troubleshooting, please contact with the place of purchase.	

WWW.NANLITE.COM | 13

3. MENU Button: Press the MENU to enter the menu.

The PavoSlim 120B has built-in OUTPUT MODE, ADDRESS/DMX, WIRELESS CONTROL, ROTATE SCREEN, SCREEN BRIGHTNESS, BUTTON BACKLIGHT, LANGUAGE, FIRMWARE UPDATE, RESET ALL SETTINGS and VERSION.

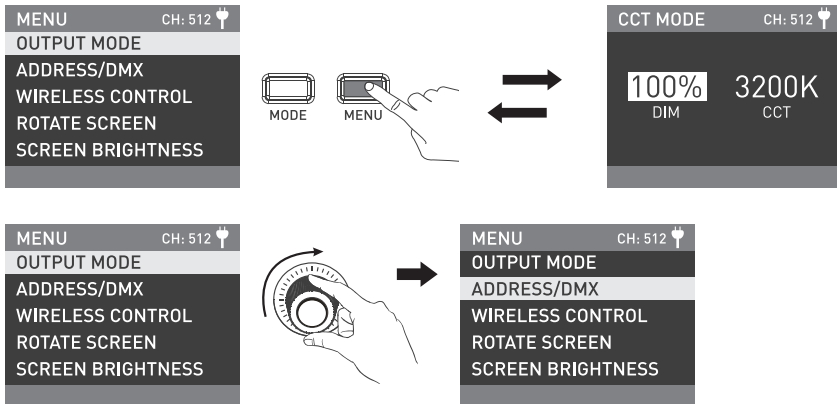

Rotate the "right knob" to select the option, press the "right knob" to enter the secondary menu, and rotate the "right knob" to select the required option, then press the "right knob" to set. Press the MENU button to return to the previous menu.

4. When the fixture is not in use, please turn off the power switch.

2. Connection Between Light Fixture and Control Unit with Battery

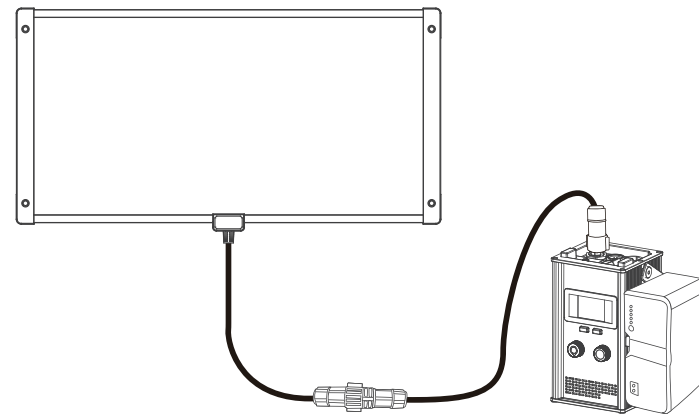

Note:

- 2.1 Please do not exert too much force when mounting the battery, to avoid damage and deformation of the battery holder.
- 2.2 Please press the battery lock catch when removing the battery, to avoid damage of the battery holder.
- 2.3 V-mount battery holder is for mounting 14.4-14.8V or 26V V-mount batteries.

### 3. Installation and Detachment of Quick Release Clamp (optional purchase)

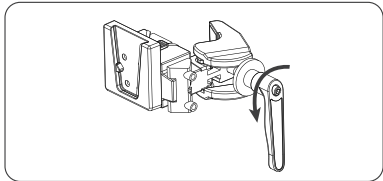

Rotate the adjustable handle to release the clamp.

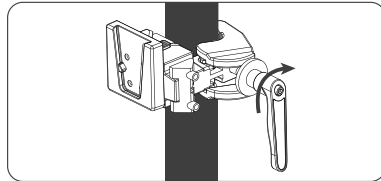

Mount the quick release clamp on the light stand, then rotate the adjustable handle to tighten the clamp.

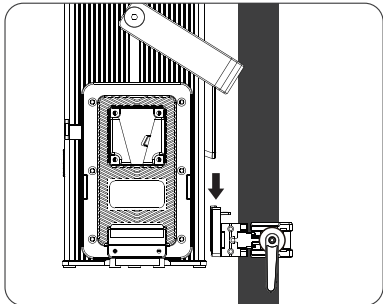

Align the quick release plate on the control unit with the quick release mount on the clamp to mount the control unit on to the clamp.

06 | NANLITE

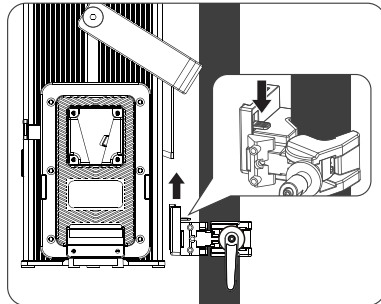

Press the lock catch on the clamp to remove the control unit from the light stand.

### Operating Instructions

1. Make sure the power switch of the control unit is off. Connect with the fixture and power cable or mount the battery, then turn on the power switch, the screen will display "NANLITE".

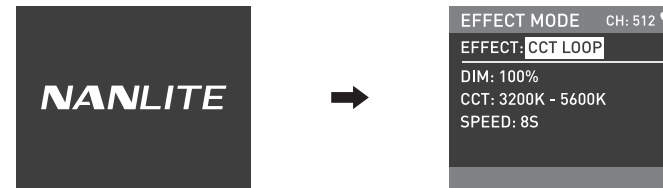

2. MODE Button: Press the MODE button to switch between CCT and effect mode.

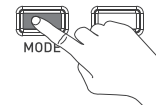
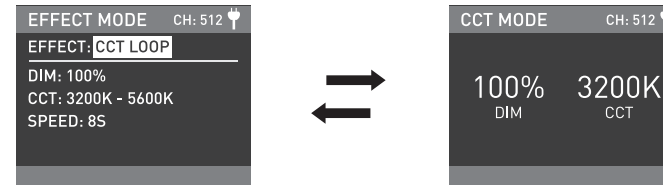



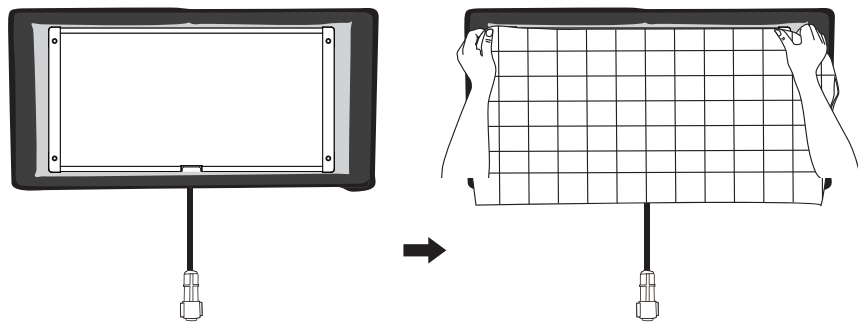

4.4 Attach the eggcrate to the hook and loop fasteners on the inside of the softbox.

#### 4. Installation of Softbox and Diffuser

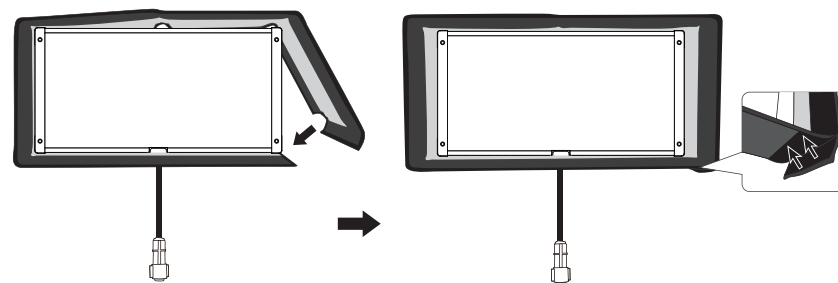

4.1. Unfold the softbox, wrap the softbox around the fixture body and stick at the interface.

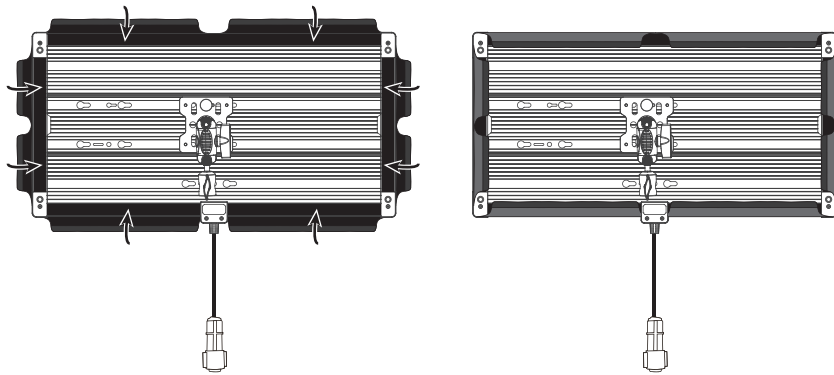

4.2 Attach the hook and loop fasteners on the back of softbox to the back of the fixture.

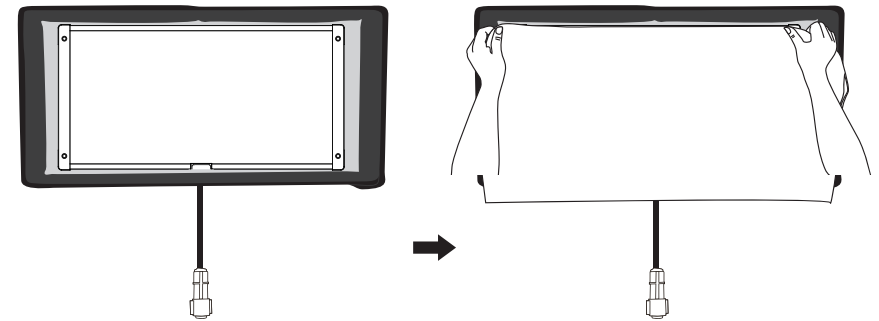

4.3 Attach the diffuser to the black hook and loop fasteners on the inside of the softbox.  
Note: There are included two diffusers: lite diffuser and standard diffuser.